

EuroDist System

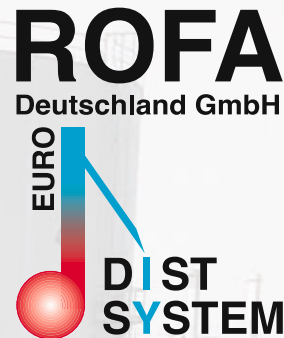

Laboratory Distillation Plants
ASTM D 2892 and D 5236

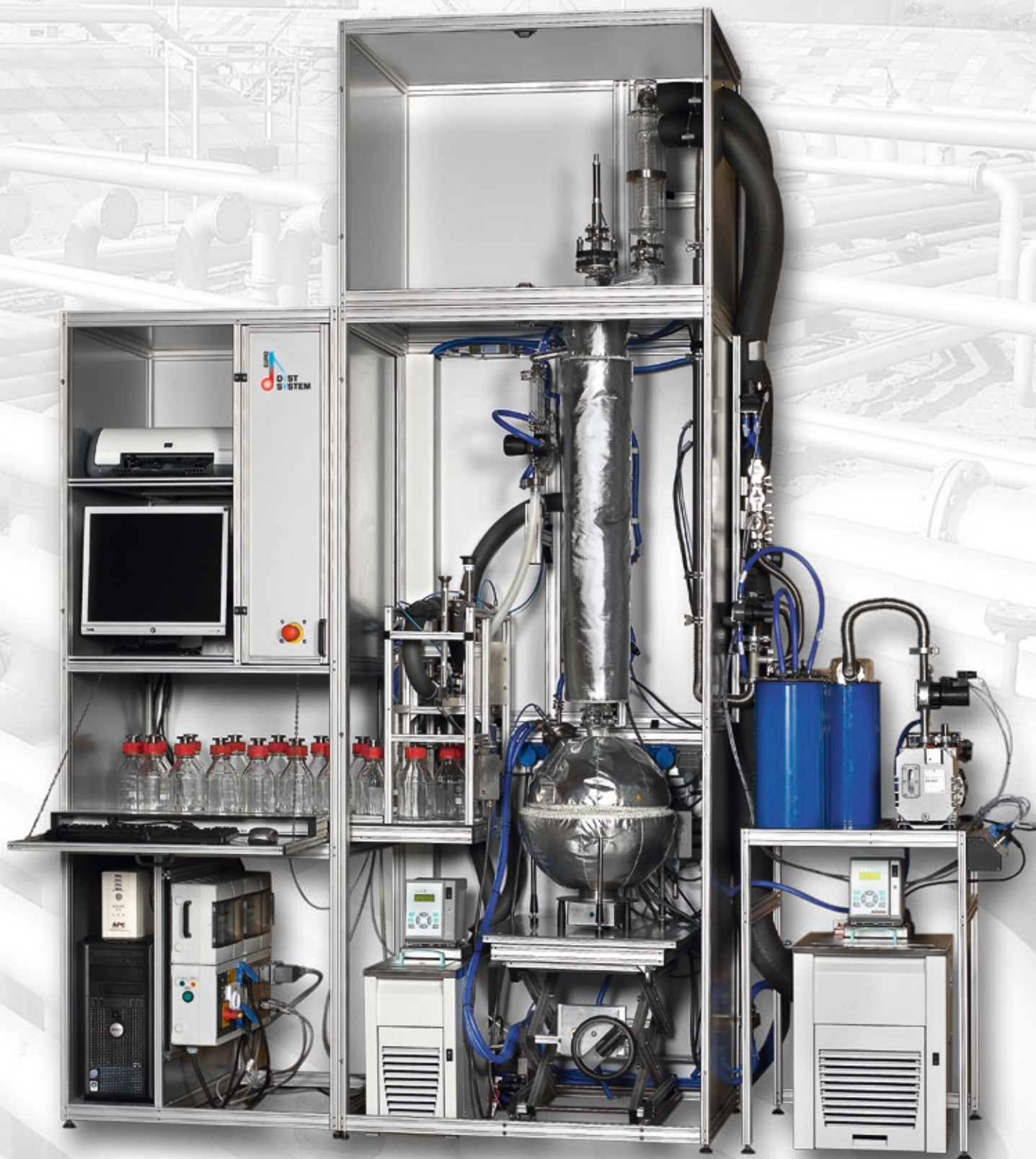

ROFA Germany produces distillation plants in sizes ranging from 100 ml to 250 litres. With over 100 units sold from 2002 to 2009, the brand name EuroDist has spread all around the world. Excellent performance and a surprising simplicity in servicing and maintenance make distillation jobs as simple as possible. Safety features, which include the monitoring of most common process gases, fire or smoke detection and a redundant safety concept in soft- and hardware control support today's laboratory safety requirements.



The sophisticated framework concept offers a maximum of flexibility in standard or custom tailored constructions. The framework is constructed modularly, thus fast to assemble or dismantle. Our philosophy is not to hide, but to show all parts of the plant. This allows seeing into the plant function and minimises service time. The plant can stand right in front of a wall; with all services carried out from the front of the unit. Valuable laboratory space can therefore be saved.

The picture shows a Combi-Plant with an 20/10 litre TBP (ASTM D 2892) and a 10/6 litre Potstill (ASTM D 5236), with a cooling station (for operation without requiring dry ice for gas- and cold trap cooling).





The ASTM D 2892, also called TBP (True Boiling Point) can fractionise crude oils from 15°C up to 420°C AET (atmospheric equivalent temperature) at pressure stages down to 1 Torr.

The distillation column has 15 -18 theoretical plates and complies fully with the ASTM D 2892.

Different column packings are available:

Propac (mostly used), Helipac, SulzerPac, Raschig-Rings (metal or glass) or others upon request. Also real plate columns are available. The distillation plant runs entirely automatically starting from debutanization at atmospheric pressure via several vacuum stages down to a minimum pressure of 1 Torr and a final cooling sequence.

Soft- and Hardware are constructed for unattended operation and fulfil most today's laboratory safety requirements. Fractions are collected and measured in their final receiver, which are sealed closed when a receiver is changed. The butane fraction is collected in two gas traps. The cooling of the gas traps can be done by using dry ice or a thermostat (-60 °C).

Technical data: EuroDist TBP-S10W

Max. temperature flask °C	400
Max. temperature AET °C	420
Minimum operation pressure Torr	1
Flask size l	10 litre
Column diameter (DN) mm	36
Receiver size ml	500
Max. receivers on Conveyor Belt	28
Flask material	Stainless steel or glass
Max. cuts	99
Utility requirements	
Electrical (3P+N+PE) V	400
Hz	50
A	16
Compressed air bar	6 (dry, not oiled, particle filter)
Nitrogen bar	2 (dry, technical quality)
Water bar	2 (particle filter)
Ambient conditions	
Temperature °C	10 - 35
Rel. humidity %	80
Dimensions	
Width mm	3000
Depth mm	700
Height mm	2700
Weight (approximately) kg	600



The ASTM D 5236 (Potstill) can fractionize crude oil or crude oil residue from 15°C up to 565 °C (at atmospheric equivalent temperature); from atmospheric pressure down to a vacuum of 0,1 Torr.

The column design complies fully with the ASTM D 5236 method. In normal operation mode, the plant completes a preheating and evacuation to the first vacuum stage (1 Torr), distilling until a predetermined flask temperature and reduces pressure to 0,2 Torr while continuing distillation.

After the final cut, it carries out a final cooling sequence. There is a special mode which allows (performing / completing – which you prefer) a full distillation including an initial debutanization. This is especially interesting for customers who have the knowledge in data conversion from Potstill yields to TBP yields, as it can save up to 80% of the distillation time.

Technical data: EuroDist PS-S6

Max. temperature flask °C	400
Max. temperature AET °C	580
Minimum operation pressure Torr	0.1
Flask size l	6 litre
Column diameter (DN) mm	36
Receiver size ml	500
Max. receivers on Conveyor Belt	28
Flask material	Stainless steel or glass
Max. cuts	99
Utility requirements	
Electrical (3P+N+PE) V	400
Hz	50
A	16
Compressed air bar	6 (dry, not oiled, particle filter)
Nitrogen bar	2 (dry, technical quality)
Water bar	2 (particle filter)
Ambient conditions	
Temperature °C	10 - 35
Rel. humidity %	80
Dimensions	
Width mm	1800
Depth mm	700
Height mm	2300
Weight (approximately) kg	500



The TBP-L series (L = large, from 50 to 250 litre) has the same framework concept as the Standard TBP plants, but there are some extra features, which separate the EuroDist System plants from the competition.

The reflux divider and main condenser are installed on a moveable support, which can be lifted up and down by an electric winch. If any service or installation work is required, the whole construction can be driven down to floor level - from a height of approximately 4 meter for a 50 litre plant – by simply pushing a button. No more risky climbing on high ladders and no more fear of breaking heavy and expensive glassware!

The main condenser has two separate circuits which are powered by two independent thermostats; therefore allowing operation at lower distillation rates, if one thermostat is not available.

The big flask is installed on a movable support. It has a drain valve at the bottom with big and robust wheels guaranteeing a good rolling motion.

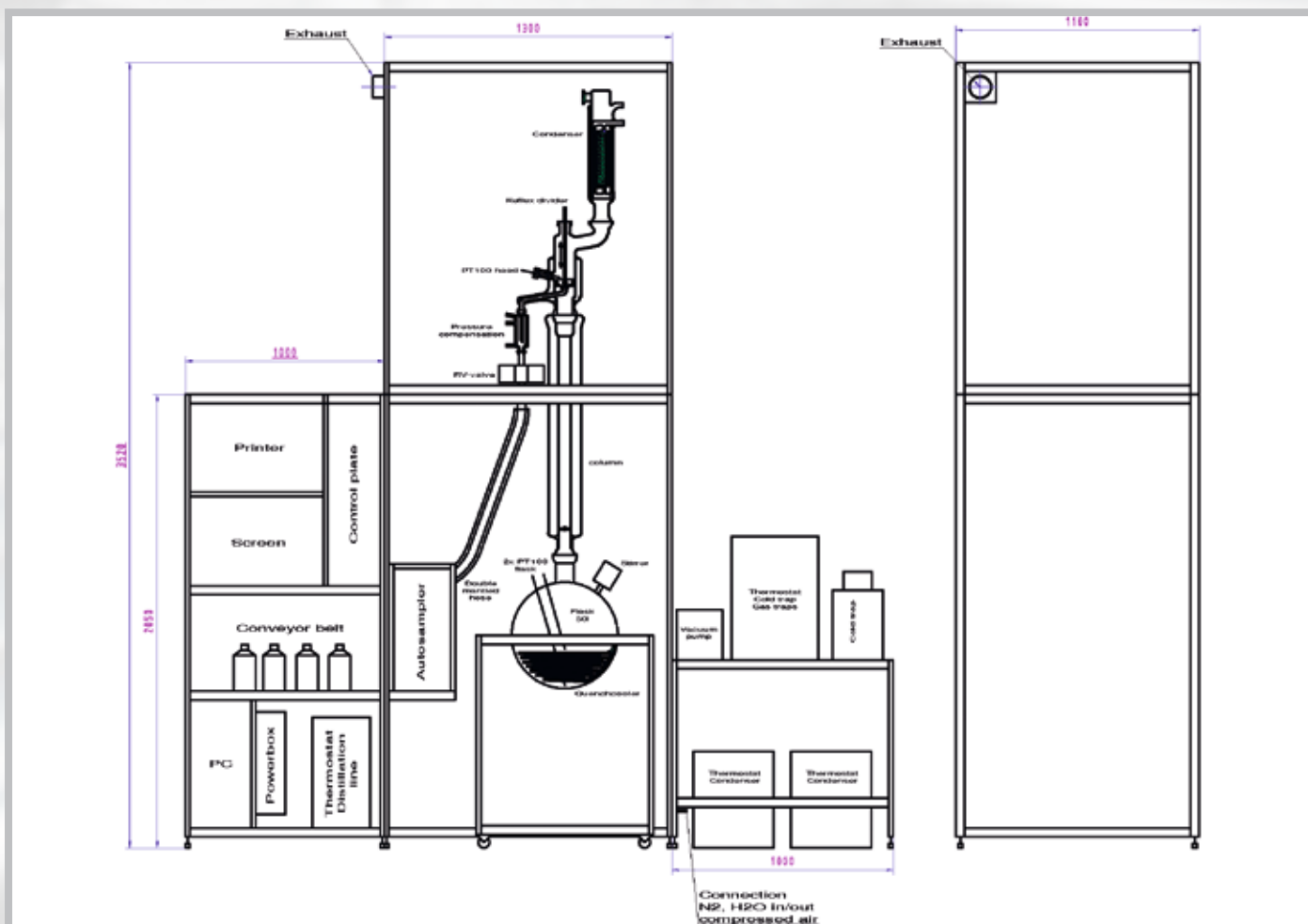



The Potstill-L models have a bigger framework and a movable flask support. For safety reasons and easy access, the big and heavy cold trap is situated close to floor level. The support can swing out, which simplifies any service work.

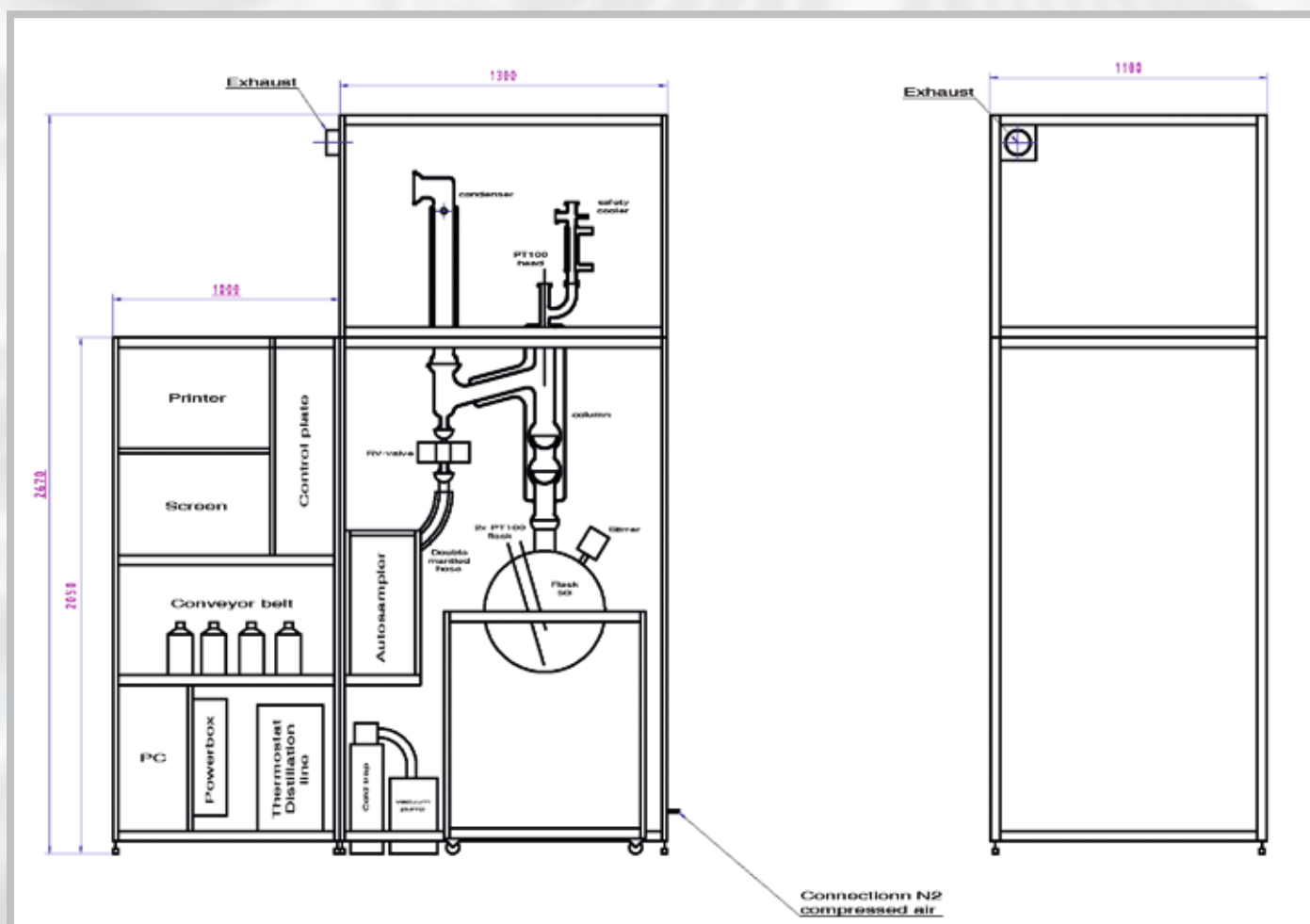

MPS (Mini Potstill) and TBP-M models have the same compact framework design. Thermostats are standing at the rear side and are accessible from the left or right side. The framework stands on rollers. The computer table can be placed at the left or right side.

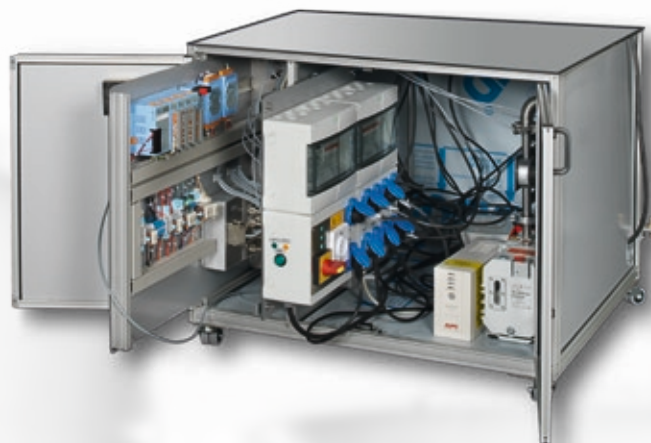

MPS and TBP-M have a carousel, instead of a conveyor belt. The carousel runs within a chamber, which has a front door. The chamber can be heated up to 90°C. It includes a volume follower system, cut weighing equipment and bottle closing.

The carousel can be made for 6, 12 or 24 receivers.

The TBP-M models have a column size of 500 ml up to 2 litre, with flask sizes ranging from 500 ml to 4 litres.

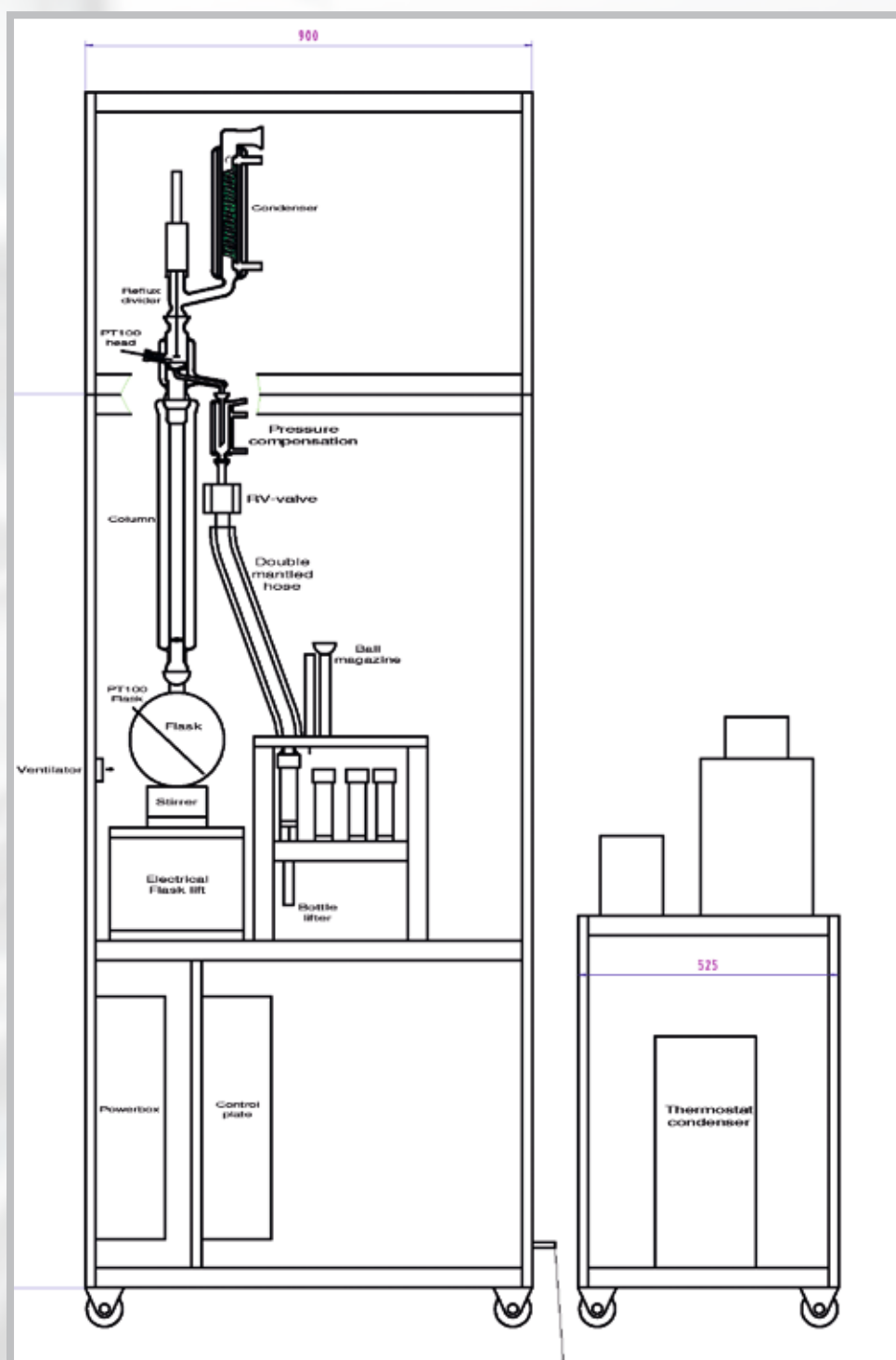

TBP - Column Design

The most remarkable innovation of EuroDist came onto the market, when we changed the column design to ease the assembly of the column.

Today, any of the various column sizes can be changed within two minutes! It also allows using different column diameters or columns with different packing in the same plant.

No tools are required and no ladder is needed to do the changing. One single person can do this job; eliminating the risk of breaking other parts.





The high efficient triple mantle Condenser offers a large heat exchange surface, which exist of 2 separate internal coils and an external double mantle.

An outer, high-evacuated double mantle prevents from condensation of humidity and thermal losses. A thermostat runs alcohol or any other suitable medium at temperatures down to -30°C . No cooling water is required!

The special construction limits the total height of a 20 litre TBP to only 270 cm.



TBP - Reflux Divider Design

The second highlight is the pneumatic driven reflux divider. This replaces the old fashioned reflux divider design which uses a glass plunger falling into the valve seat; also made of glass. This type of construction will/can leak within a short time.

Therefore, they have to be grinded frequently and the grinding needs someone with experience in working with glass and takes a great amount of time.

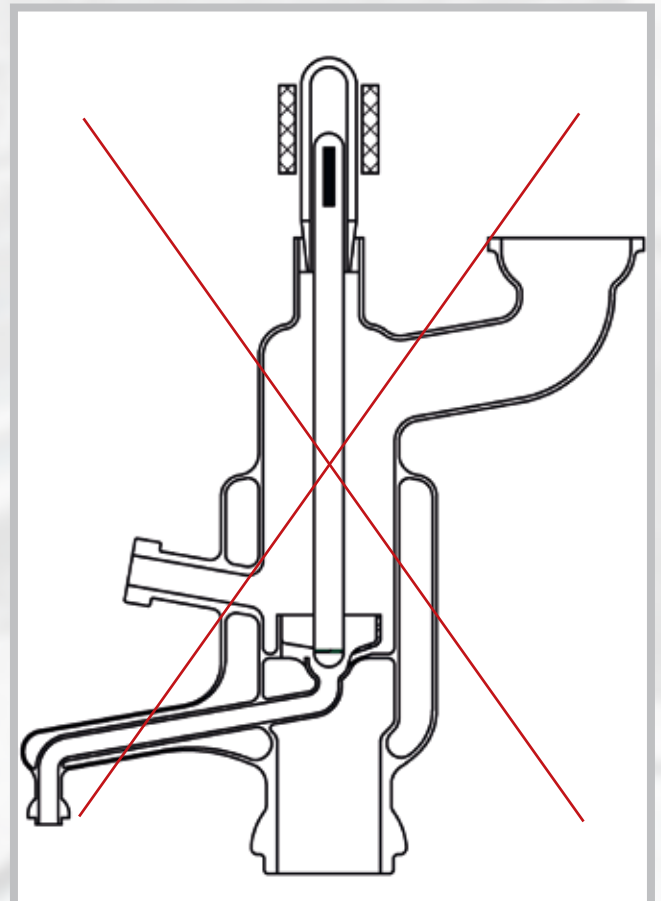
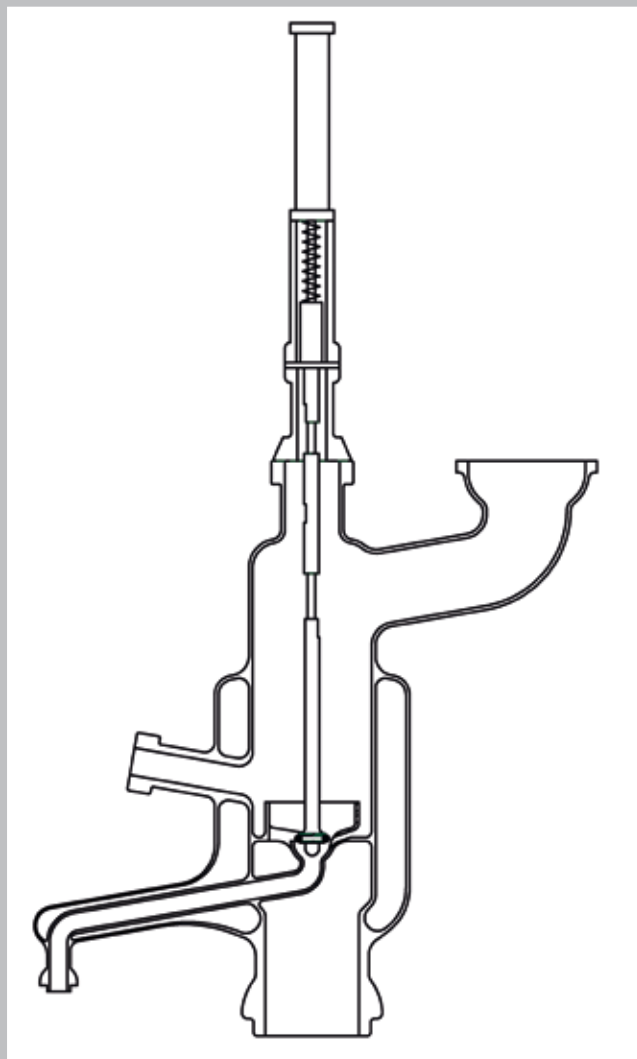

Our reflux divider has a stainless steel or ceramic rod with an O-Ring at the bottom. This O-Ring is pressed into the valve seat with a force of approximately 1 kg and seals the valve with its soft surface.

This construction offers a leakage free operation. The reflux divider can be dismantled for O-Ring replacement, which takes less than two minutes.

On average, this job has to be done after 25 distillations (using inexpensive Viton O-Rings).



- No glue effect because of condensation of waxy fractions
- Pneumatic driven plunger with O-Ring seal
- Leakage free construction
- fast O-Ring changing
- Teflon made vacuum throughput
- plunger rod can be made of stainless steel or ceramic
- no grinding required
- different head temperature sensors available: Stainless steel, Teflon coated, Glass

TBP - Sensors and Controls

All build in temperature controllers use high accurate PID algorithms, which regulate all processes from preheating to following a distillation rate or a differential pressure process variable until final cooling. The PID controllers are integrated into the PLC system.



Only column and flask properties (sizes) have to be chosen from a table. All other operation data are set automatically in accordance to customer specific cut temperatures.

Only proven, H₂S resistant sensors are build in. PT 100 sensors (4 wire type) are interchangeable without the need of recalibration.



The vacuum control system, vacuum pump, vacuum and differential pressure sensor, gas- and cold traps and the thermostat for the main condenser are all on the right side; outside of the framework.

Vacuum and differential pressure sensors are connected via a protective cooler, which is working in parallel to the main condenser circuit. As a result, this means a maximum protection against aggressive and destructive vapours is in place. Additional joints allow the addition of reference sensors for checking and calibration.

A two stage rotary vane vacuum pump creates the vacuum, which is controlled by a proportional and a bypass valve.



Autosampler Design



Our Auto sampler executes the following functions:

- Measurement of volume by using a combination of a stepper motor, belt drive and light barrier. The distillation rate is calculated and is used to control the flask heater
- Detection of maximum volume condition, which triggers a bottle changing.
- A second light barrier, installed at a fixed position, detecting the bottle at lifting position.
- A balance weighs the empty bottle and later the filled bottle. By comparing the two weights, the cut weight can be calculated.
- A lifting device with a movable fork system and a pneumatic cylinder taking the bottle from the belt and pressing it into the outlet device of the distillation line.
- A combination of a pressure sensor and three valves can evacuate the bottle to column pressure level or can pressurize it with N₂ after a cut.



Some customers prefer to have an intermediate receiver. We can supply Standard and Large TBP plants with intermediate receivers of sizes ranging from 250 ml up to 5 litres.



Lifting Platform



Standing very close to the platform offers a painless charging and discharging of heavy flasks. The platform has a mechanical drive, which can be turned without the need for strength.

An electric drive is also available. The platform can carry any weight up to 100 kg. It can travel a distance of 550 cm, which allows the use of different flask sizes and column length's.

Our superb lifting platform does not only travel up and down, but can additionally be pulled out!

A plant can be changed from a 6 litre size to a 20 litre size (for example) within 5 minutes.

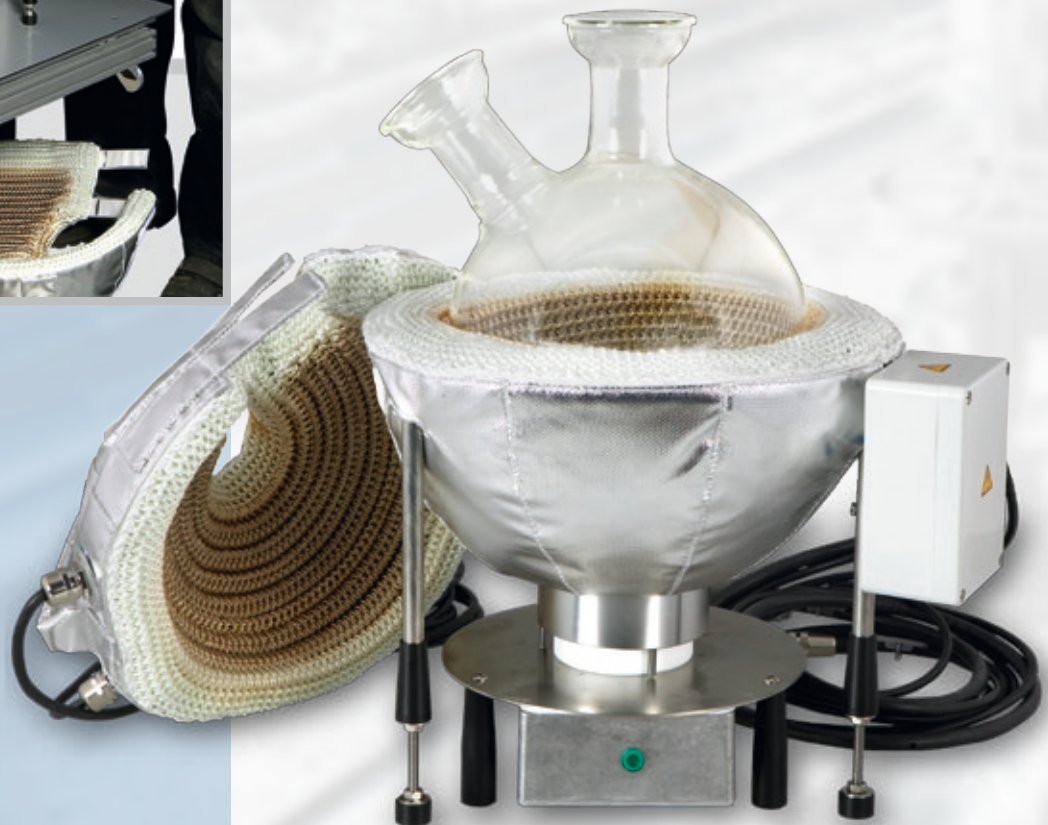

TBP - Cooling Station

We offer an external thermostat, which goes down to approximately $-60\text{ }^{\circ}\text{C}$ and a double insulated, stainless steel cooling vessel, that supplies all the cold- and gas traps.

It has removable and supplementary insulated tops to prevent thermal losses. With this accessory installed, no dry ice is necessary.



TBP - Water Removal



The water removal system is available as an accessory for TBP and Combi plants. It consists of a double mantle glass vessel (collector vessel) with internal quench cooler and bottom drain valve. The vessel can be removed when not in use. The collector vessel can be charged with 5 litre water/distillate mixture. Other sizes, like 10 or 20 litre (for large TBP's) are also available.

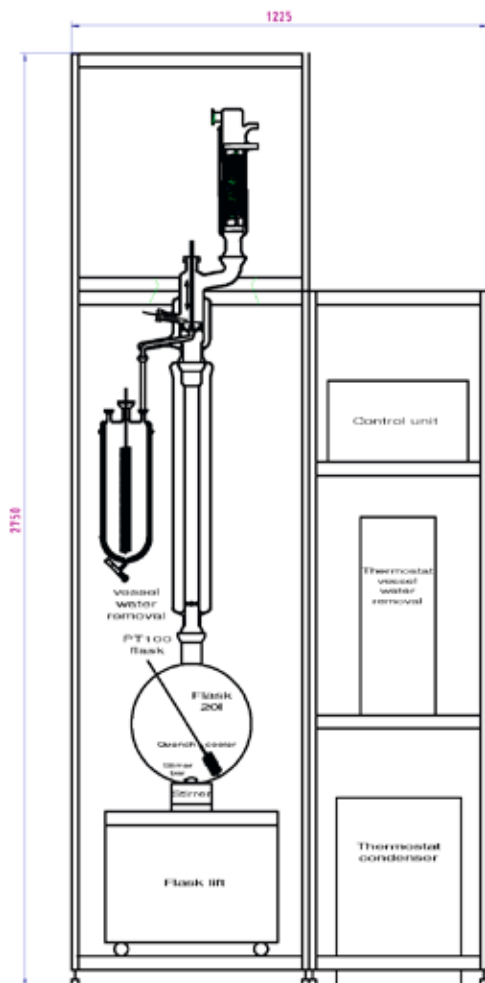

Alternatively, a stand alone water removal system is available. It comes with a complete framework with front doors, a complete set of glassware (condenser, reflux divider and column) and flask heater (with stirrer). The system comes with two thermostats; one for the condenser; one for the collector vessel. The plant has its own control system, which allows an unattended operation.

As second alternative, we offer the TBP-W models. This TBP or Combi plants have a slightly wider framework for an additional set of TBP glassware.

All other parts, like flask heater and thermostats, are shared with the standard system.

TBP-W

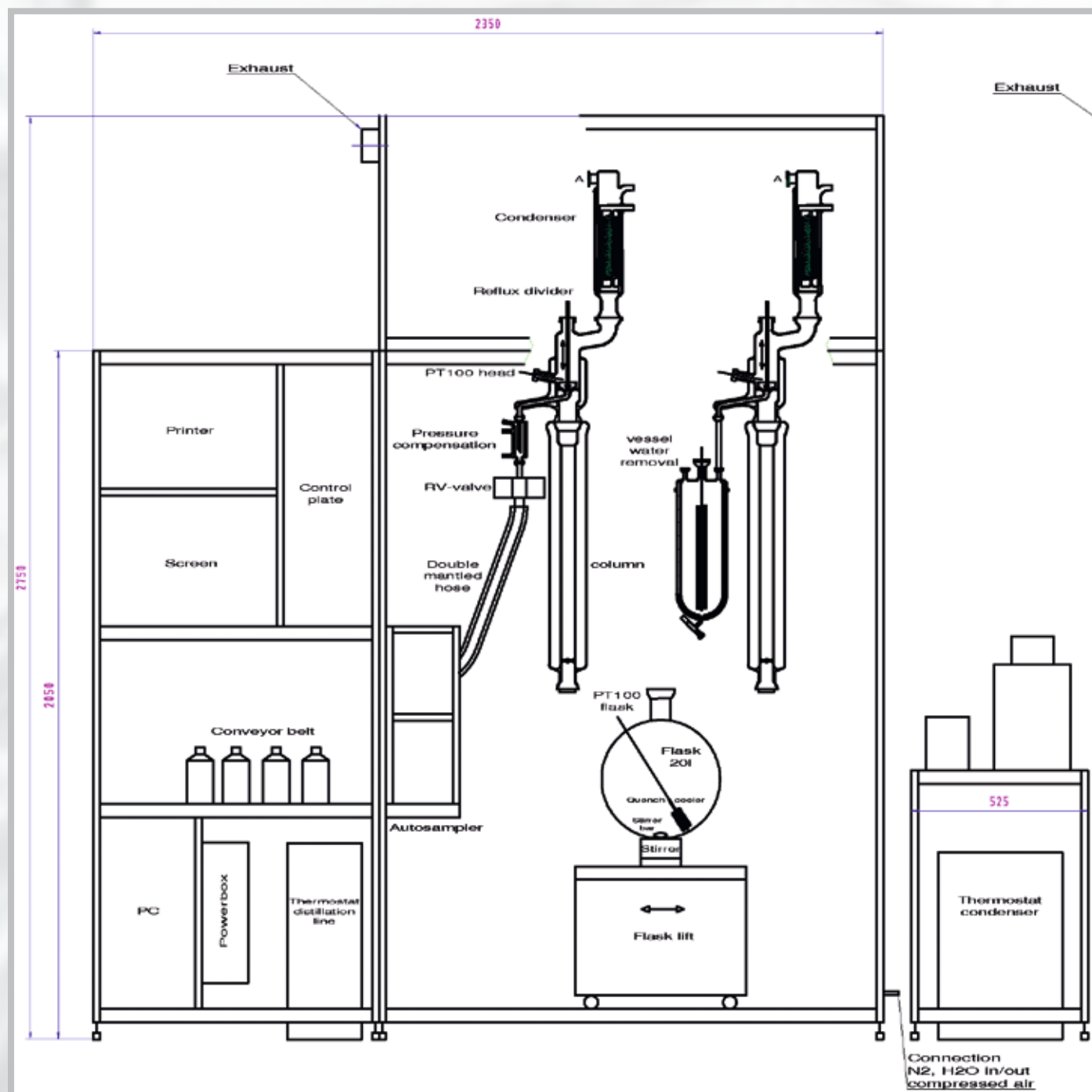

Accessories



The fire extinguishing system consists of an infrared fire and smoke sensor, a detector electronic housing, it's own UPS box with charging unit and backup battery, an electromechanical trigger device and a bottle with Argon or Nitrogen.

Pressure shrinking, cable faults and UPS faults are detected and trigger a shutdown of distillation while in unattended operation. If fire is detected, extinguishing takes place; all heaters and pumps are shut off and all valves are closed.

Additionally, we can offer a wide variety of other accessories :

- Gas detectors (from Butane to Toluene)
- H₂S detectors
- Water filter station with water pressure reducer
- Cooling water supply with 250 litre tank and circulation pump
- Compressed air and nitrogen filter
- Different types of cooling stations for single and Combi plants
- Extended conveyor belts
- Flask with feed and drain for continuous operation
- Custom tailored accessories

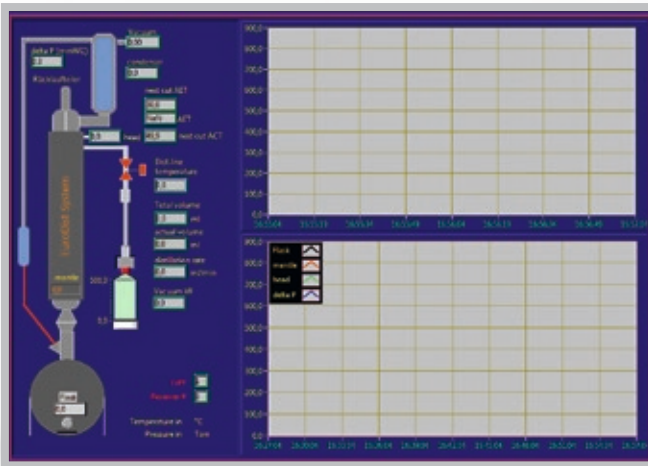

EuroDist Control software runs under Windows operation system (latest version).

When connected to a LAN, the control computer can be operated from anywhere within the network, even through Internet, if enabled by customer. ROFA Germany offers a worldwide remote service for trouble shooting or distillation process assistance.

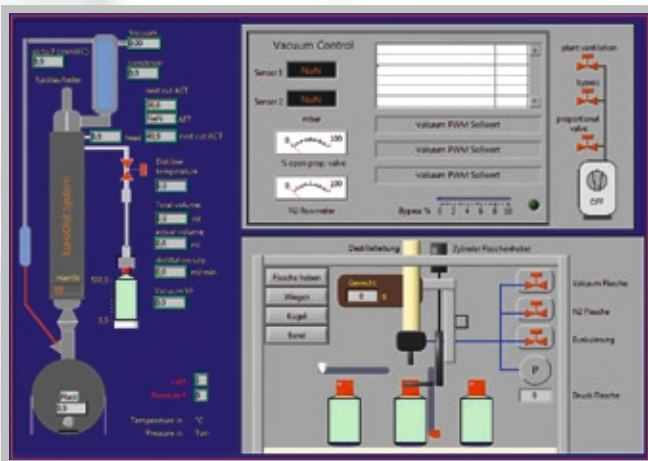

- Full flowchart of the distillation unit
- Distillation process controlled and regulated automatically to ASTM standards
- 2 running modes: manual and fully automatic operation
- Distillation can be interrupted at any time. After continuation, the data are combined to one data file. Also several interruptions are possible.
- Calibration Software for all probes
- Scale weighing program (optional)
- Calibration program for Pt100 sensors and vacuum probes

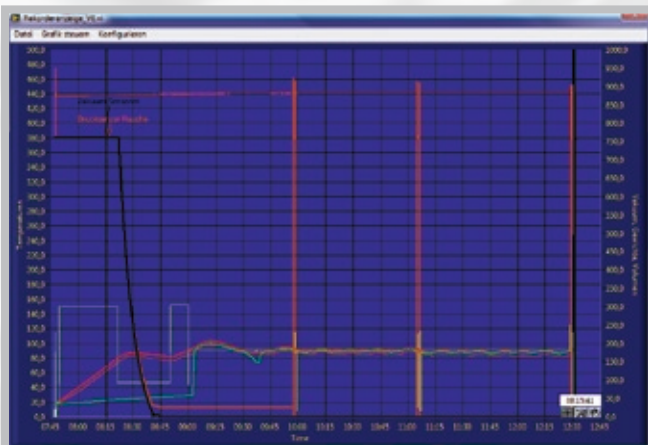

- All the readings are stored and can be displayed in various windows during the distilling process
- All data are collected in adjustable time intervals
- Data can be transferred to spreadsheet programs
- External watchdog supervises software control
- Access to input and output functions in real time
- Loads and saves parameter settings to hard disk or floppy disk

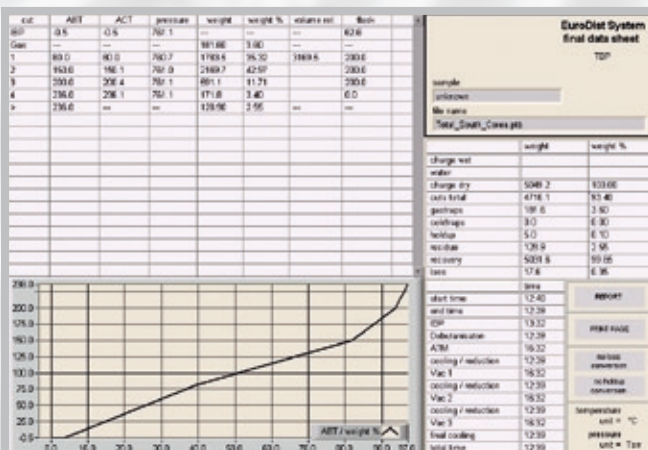

A report of the distillation is generated automatically after distillation. A dialog based program asks user to complete entries for weights (cold- and gas traps) Data fro TBP and Potstill can be merged to one single report.

Reports can be printed out as Word document, as HTML document or can be exported to spreadsheet programs.

ROFA

Deutschland GmbH



ROFA Deutschland GmbH
EuroDist System

Gutenbergstraße 6 a
D 53359 Rheinbach

Tel.: +(49)2226 / 16 90 -63/ -64

Fax: +(49)2226/ 16 90 -65

office@rofa-germany.de

www.rofa.at