

## Pass-through oven UF160TS

The Memmert pass-through oven saves time when loading and reduces the danger of contamination, especially when directly transporting the chamber load between the grey room and the clean room.

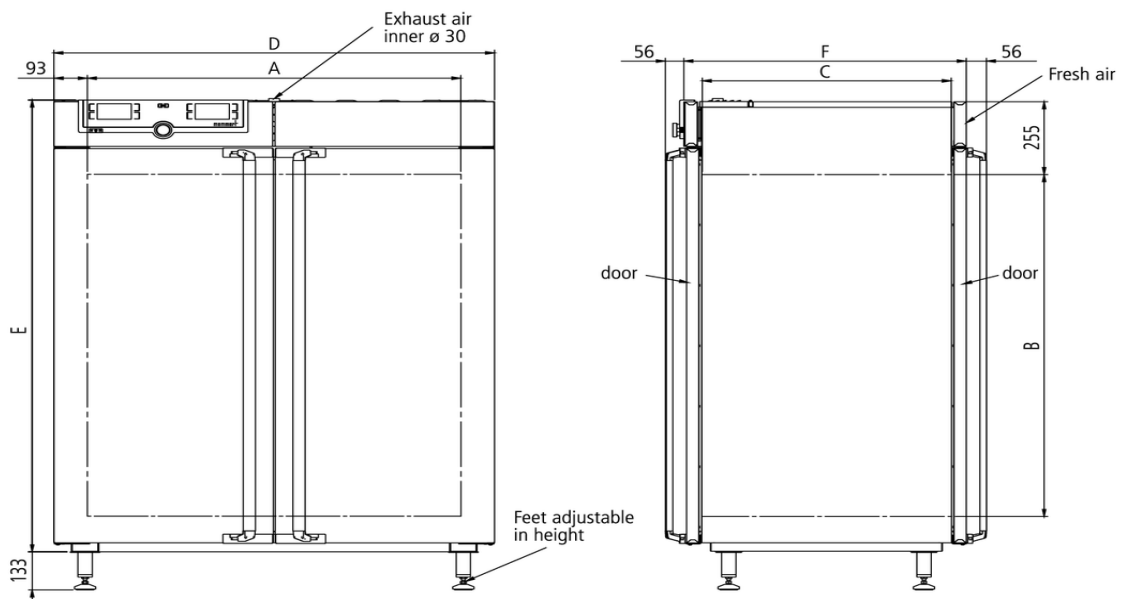

The Memmert heating oven with fully insulated stainless steel door on both sides saves time during loading and reduces the risk of contamination, specially when handling sensitive load between grey and clean rooms. On this page, you can find all the essential technical data on our pass-through oven. Our customer relations team will be pleased to help if you want further information. If you should require a customised special solution, please contact our technical specialists at [sales@memmert.com](mailto:sales@memmert.com).



## Temperature

<b>Working temperature range</b>	at least 10 above ambient temperature to +250 °C
<b>Setting accuracy temperature</b>	up to 99.9 °C: 0.1 / from 100 °C: 0.5
<b>Setting temperature range</b>	+20 to +250°C
<b>resolution of display for actual values</b>	0.1°C
<b>Temperature sensor</b>	2 Pt100 sensors DIN Class A in 4-wire-circuit for mutual monitoring, taking over functions in case of an error

## Control technology

<b>ControlCOCKPIT</b>	TwinDISPLAY. Adaptive multifunctional digital PID-microprocessor controller with 2 high-definition TFT-colour displays.
<b>Language setting</b>	German, English, Spanish, French, Polish, Czech, Hungarian
<b>Timer</b>	Digital backwards counter with target time setting, adjustable from 1 minute to 99 days
<b>Function HeatBALANCE</b>	adapting the distribution of the heating performance of the upper and lower heating circuit from -50 % to +50 %
<b>Function SetpointWAIT</b>	the process time does not start until the set temperature is reached
<b>Calibration</b>	three freely selectable temperature values

## Ventilation

<b>Fan</b>	forced air circulation by quite air turbine, adjustable in 10 % steps for each segment individually
<b>Fresh air</b>	Admixture of pre-heated fresh air by electronically adjustable air flap
<b>Vent</b>	vent connection with restrictor flap

## Communication

<b>Documentation</b>	programme stored in case of power failure
<b>Programming</b>	AtmoCONTROL software on a USB stick for programming, managing and transferring programmes via Ethernet interface or USB port

## Safety

<b>Temperature control</b>	independently working, digitally adjustable electronic micro-processor overtemperature monitor TWW, protection class 3.1 (max-value for overtemperature, min-value for undertemperature)
<b>Temperature control</b>	mechanical temperature limiter TB, protection class 1 according to DIN 12880 to switch off the heating approx. 20°C above nominal temperature
<b>AutoSAFETY</b>	additionally integrated over- and undertemperature protection "ASF", automatically following the setpoint value at a preset tolerance range, alarm in case of over- or undertemperature, heating is switched off in case of overtemperature
<b>Autodiagnostic system</b>	for fault analysis
<b>Alarm</b>	visual and acoustic

### Standard equipment

<b>Internals</b>	2 stainless steel grid(s), electropolished
<b>Door</b>	fully insulated stainless steel doors on two sides
<b>Installation</b>	with feet

### Stainless steel interior

<b>Interior</b>	easy-to-clean interior, made of stainless steel, reinforced by deep drawn ribbing with integrated and protected large-area heating on four sides
<b>Volume</b>	161 l
<b>Dimensions</b>	$w_{(A)} \times h_{(B)} \times d_{(C)}$ : 560 x 720 x 400 mm
<b>Max. number of internals</b>	8
<b>Max. loading of chamber</b>	210 kg
<b>Max. loading per internal</b>	20 kg

### Textured stainless steel casing

<b>Dimensions</b>	$w_{(D)} \times h_{(E)} \times d_{(F)}$ : 745 x 1233 x 582 mm (d +2x56mm door handle)
<b>pass-through version</b>	

### Ambient conditions

<b>Altitude of installation</b>	max. 2,000 m above sea level
<b>Ambient temperature</b>	+5 °C to +40 °C
<b>Humidity rh</b>	max. 80 %, non-condensing
<b>Overvoltage category</b>	II
<b>Pollution degree</b>	2

### Packing/shipping data

<b>Transport information</b>	The appliances must be transported upright
<b>Customs tariff number</b>	8419 8998
<b>Country of origin</b>	Federal Republic of Germany
<b>WEEE-Reg.-No.</b>	DE 66812464
<b>Dimensions approx incl. carton</b>	w x h x d: 830 x 1300 x 800 mm
<b>Net weight</b>	approx. 120 kg
<b>Gross weight carton</b>	approx. 146 kg

Standard units are safety-approved and bear the test marks

